

Article number: 021816011206

Description: Clamp with bracket and rubber
SPGU 6011. 206/30 SK

Measures

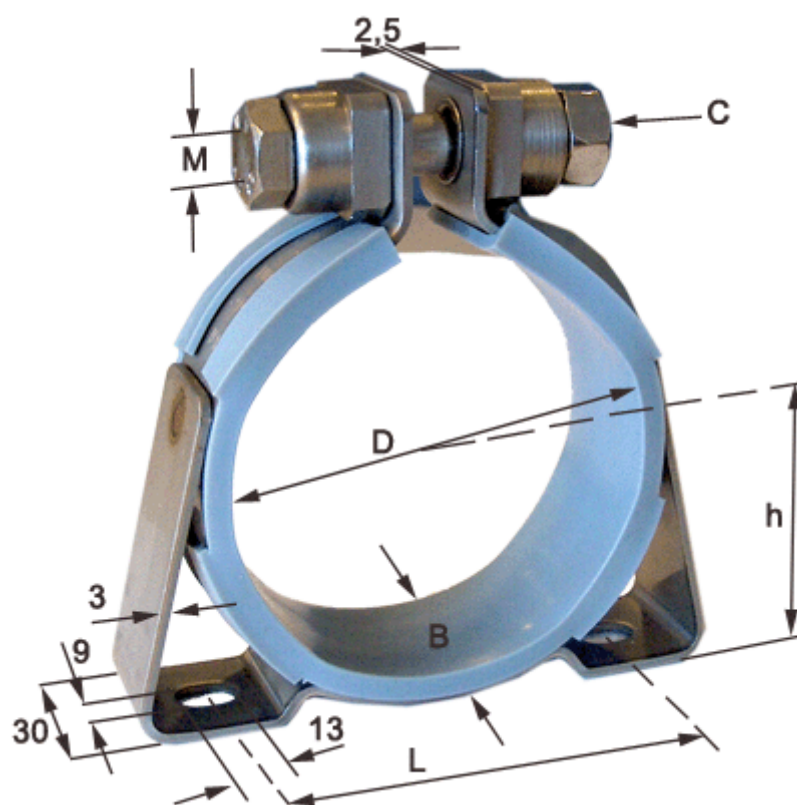

C (screw type) = SK hexagon screw

Diameter D = 206

h = 111

L = 212

Width B = 30